

detail of glazing
see vertical cross-section

FRANZEN
Feuerschutztüren
Gerhard-Welter-Straße 7; 41812 Erkelenz

double leaf steel fire door
E120/EW60
"System Schröders ES-2"
horizontal cross-section

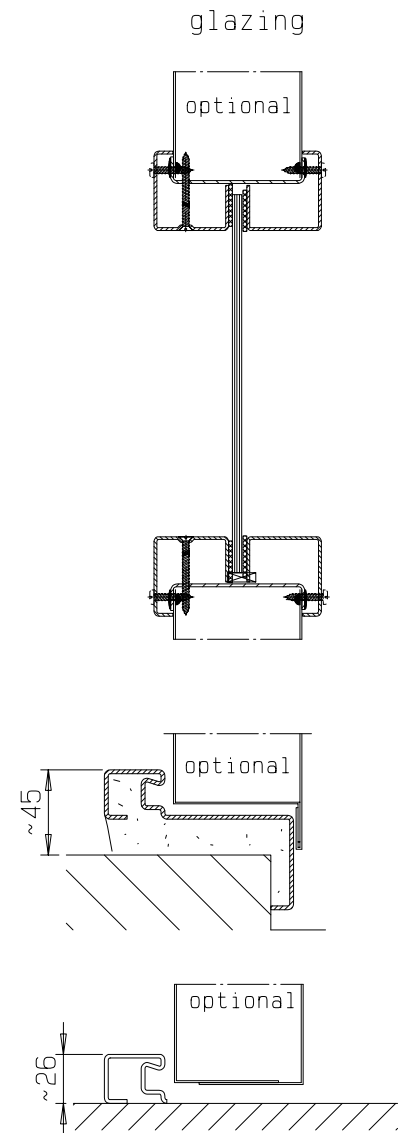
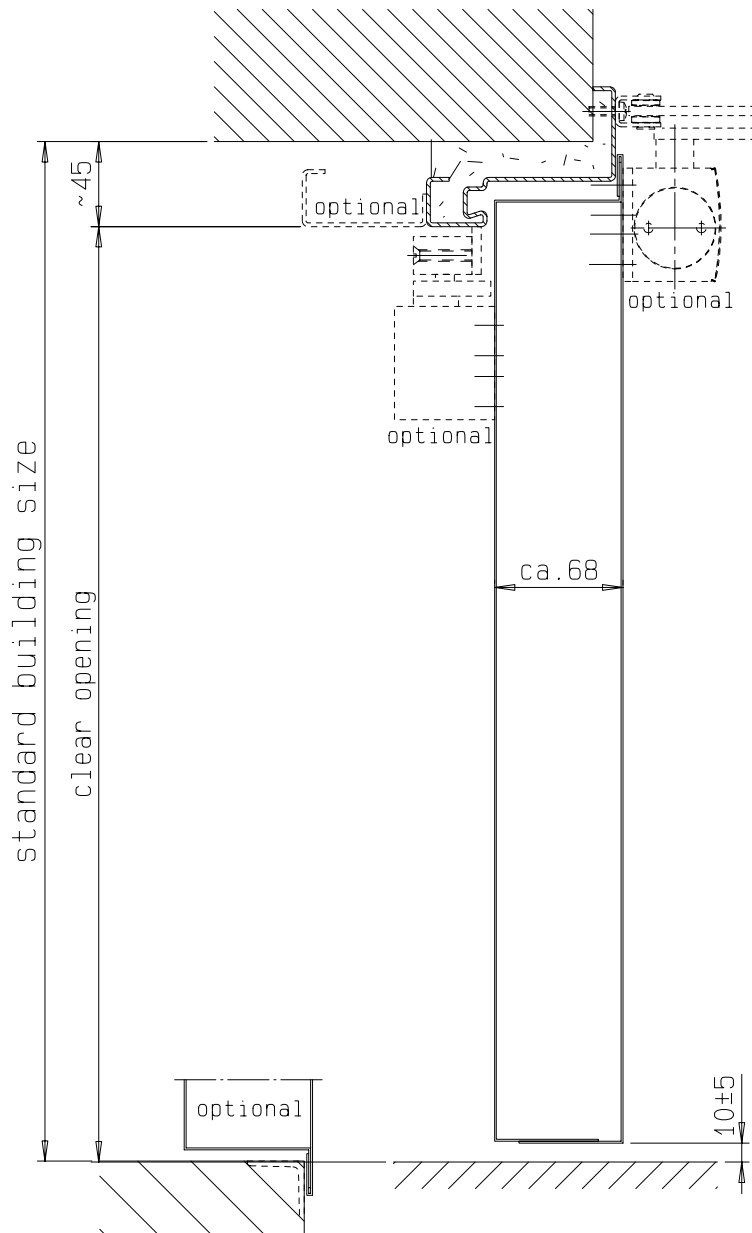

fitting details respectively frames, look at horizontal cross-section



FRANZEN
Feuerschutztüren

Gerhard-Welter-Straße 7; 41812 Erkelenz

double leaf steel fire door
E120/EW60

"System Schröders ES-2"

vertical cross-section